

4. Alignment and Adjustments

4-1 Preadjustment

4-1-1 Factory Mode

1. Do not attempt these adjustments in the Video Mode.
2. The Factory Mode adjustments are necessary when either the EEPROM (IC902) or the CRT is replaced.
3. Do not tamper with the "Adjustment" screen of the Factory Mode menu. This screen is intended only for factory use.

4-1-2 When EEPROM (IC902) Is Replaced

1. When IC902 is replaced all adjustment data revert to initial values. It is necessary to re-program this data.
2. After IC902 is replaced, warm up the TV for 10 seconds.

4-1-3 When CRT Is Replaced

1. Make the following adjustments AFTER setting up after setting up purity and convergence :

White Balance
 Sub-Brightness
 Vertical Center
 Vertical Size
 Horizontal Size
 Fail Safe (This adjustment must be the last step).

2. If the EEPROM or CRT is replaced, set PVA to 40 (factory mode) and set SC as follows.

14 inch : 0
 20 inch : 9
 21 inch : 9

4-2 Factory/Service Mode

4-2-1 Procedure for the "Adjustment" Mode

1. This mode uses the standard remote control. The Service Mode is activated by entering the following remote-control sequence :
 - (1) DISPLAY→FACTORY.
 - (2) STAND-BY→ DISPLAY→ MENU→ MUTE →POWER ON.
2. The "SERVICE (FACTORY)" message will be displayed. The Service Mode has four components: ADJUST, OPTION and Reset.
3. Access the Adjustment Mode by pressing the "VOLUME" keys (Up or Down). The adjustment parameters are listed in the accompanying table, and selected by pressing the CHANNEL keys (▲ ,▼).

4. Selection sequences for the all system:

DOWN or UP key:
 SCT>SBT>BLR>BLB>RG>GG>BG>VSL>
 VS>VA>HS>SC>SDL>STT>SSP>PDL>
 NDL>PSR>NSR>AGC>VOL>LCO>TXP

5. The VOLUME keys increase or decrease the adjustment values (stored in the non-volatile memory) when Adjustment Mode is cancelled.
6. Cancel the Adjustment Mode by re-pressing the "FACTORY" or "Power OFF" keys.

4-2-2 Main Adjustment Parameter

OSD	FUNCTION	RANGE	INITIAL DATA	REMARK
SCT	Sub Contrast	0 ~ 23	13	
SBT	Sub Brightness	0 ~ 23	9	
BLR	Black Level offset Blue	0 ~ 15	9	
BLB	Black Level offset Red	0 ~ 15	7	
RG	Red Gain	0 ~ 63	32	
GG	Green Gain	0 ~ 63	25(Fix)	
BG	Blue Gain	0 ~ 63	31	
VSL	Vertical Slope	0 ~ 63	19	
VS	Vertical Shift	0 ~ 63	38	
VA	Vertical Amplitude	0 ~ 63	40(Fix)	
HS	Horizontal Shift	0 ~ 63	30	
SC	S-Correction	0 ~ 63	9	
CDL	Cathode Drive Level	0 ~ 15	9	
STT	Sub Tint	0 ~ 7	3	
SSP	Sub Sharpness	0 ~ 7	0	
PDL	PAL Delay	0 ~ 15	15(Fix)	
NDL	NTSC Delay	0 ~ 15	10	
PSR	PAL Sub color	0 ~ 23	2	
NSR	NTSC Sub color	0 ~ 23	5	
AGC	Automatic Gain Control	0 ~ 63	23	
VOL	Volume pre setting	0 ~ 63	10	
LCO	SECAM-L Vision IF	0 ~ 1	0	
TXP	TTX Position	0 ~ 15	9	

NOTE : PVS,PVA, PHS, parameters must be aligned using the 50Hz vertical-field rates.

4-2-3 Option Bytes

In the Service Mode, various can be selected via the Option Table. Example:

Option Table : xx xx xx xx

1	LNA	ON
2	SYSTEM	CZ
3	AUDIO	MONO
4	JACK	RCA
5	ZOOM	NOR/ZOOM/16:9
6	AUTO POWER	ON
7	SBL	OFF
8	2nd SIF	ON
9	HOTEL MODE	OFF
10	BKS	ON

4-2-4 RESET

The Reset Mode is used during factory inspection.
Function Reset:

1. Picture	Custom
2. Auto Volume	Off
3. Color System	Auto (option)
4. Sound System	D/K (option)
5. Blue Screen	Off
6. Low Noise AMP	Off (option)
7. Volume	10
8. CH. Skip	Erased
9. CH. Lock	Off
10. Timer	Off

4-3 Other Adjustments

4-3-1 General

1. Usually, a color TV needs only slight touch-up adjustment upon installation. Check the basic characteristics such as height, horizontal and vertical sync and focus.
2. The picture should have good black and white details. There should be no objectionable color shading; if color shading is present, perform the purity and convergence adjustments described below.
3. Use the specified test equipment or its equivalent.
4. Correct impedance matching is essential.
5. Avoid overload. Excessive signal from a sweep generator might overload the front-end of the TV. When inserting signal markers, do not allow the marker generator to distort test results.
6. Connect the TV only to an AC power source with voltage and frequency as specified on the backcover nameplate.
7. Do not attempt to connect or disconnect any wires while the TV is turned on. Make sure that the power cord is disconnected before replacing any parts.
8. To protect against shock hazard, use an isolation transformer.

4-3-2 Automatic Degaussing

A degaussing coil is mounted around the picture tube, so that external degaussing after moving the TV should be unnecessary. But the receiver must be properly degaussed upon installation.

The degaussing coil operates for about 1 second after the power is switched ON. If the set has been moved or turned in a different direction, disconnect its AC power for at least 30 minutes.

If the chassis or parts of the cabinet become magnetized, poor color purity will result. If this happens, use an external degaussing coil. Slowly move the degaussing coil around the faceplate of the picture tube and the sides and front of the receiver. Slowly withdraw the coil to a distance of about 6 feet before removing power.

4-3-3 High Voltage Check

CAUTION: There is no high voltage adjustment on this chassis. The B+ power supply must be set to +125 volts (Full color bar input and normal picture level).

1. Connect a digital voltmeter to the second anode of the picture tube.
2. Turn on the TV. Set the Brightness and Contrast controls to minimum (zero beam current).
3. The high voltage should not exceed 27.5KV.
4. Adjust the Brightness and contrast controls to both extremes. Ensure that the high voltage does not exceed 27.5KV under any conditions.

4-3-4 FOCUS Adjustment

1. Input a black and white signal.
2. Adjust the tuning control for the clearest picture.
3. Adjust the FOCUS control for well defined scanning lines in the center area of the screen.

4-3-5 Cathode Voltage Adjustment (Screen Adjustment)

1. Connect CRT socket pin GK to an oscilloscope probe.
2. Input a gray scale pattern. (Use a pattern generator, PM5518)
3. Use the P mode key (on the remote control) for the STANDARD picture.
4. Adjust the Screen VR (on the FBT) so that the voltage on the oscilloscope becomes $120 \pm 2.5V$ (See Fig. 4-1).

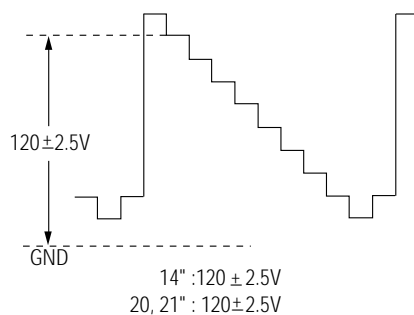

Fig. 4-1

4-3-6 Purity Adjustment

1. Warm up the receiver for at least 20 minutes.
2. Plug in the CRT deflection yoke and tighten the clamp screw.
3. Plug the convergence yoke into the CRT and set in as shown in Fig. 4-2.
4. Input a black and white signal.
5. Fully demagnetize the receiver by applying an external degaussing coil.
6. Turn the CONTRAST and BRIGHTNESS controls to maximum.
7. Loosen the clamp screw holding the yoke. Slide the yoke backward or forward to provide vertical green belt. (Fig. 4-3).
8. Tighten the convergence yoke.
9. Slowly move the deflection yoke forward, and adjust for the best overall green screen.
10. Temporarily tighten the deflection yoke.
11. Produce blue and red rasters by adjusting the low-light controls. Check for good purity in each field.
12. Tighten the deflection yoke.

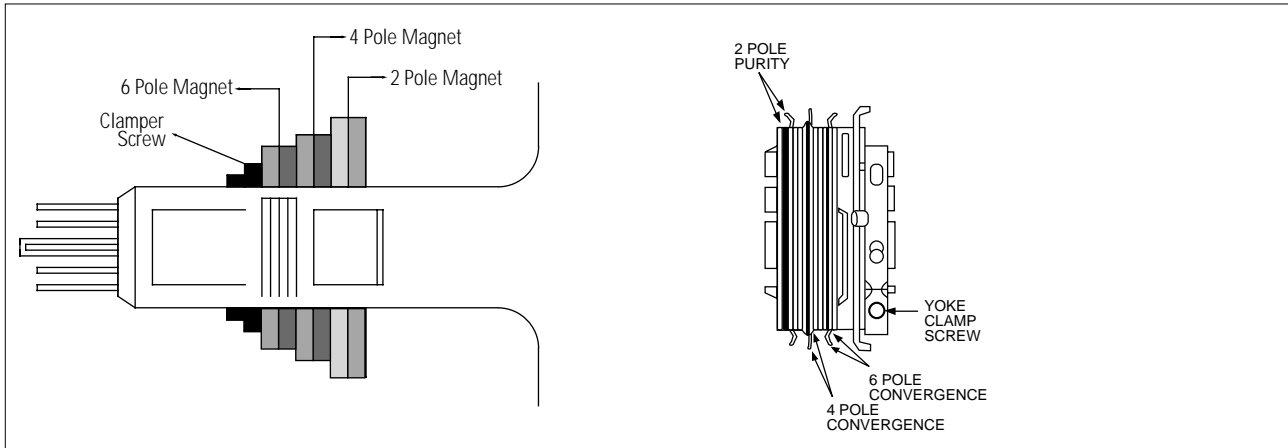

Fig. 4-2 Convergence Magnet Assembly

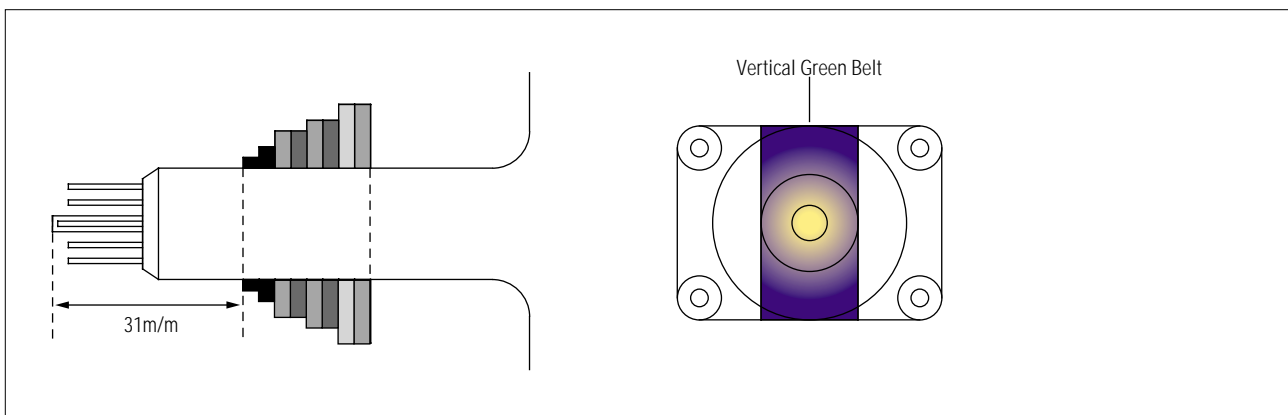

Fig. 4-3 Center Convergence Adjustment

4-3-7 White Balance Adjustment

(a) Set up

1. Warm up the TV for at least 30 minutes in the Aging Mode (OSD White). This mode is displayed by entering the following sequence:

DISPLAY →FACTORY → FACTORY

2. Input a Toshiba pattern.

(b) Low-Light Adjustment

1. Set SBT to 3.5 ± 0.5 fL in the Factory Service Mode with using CA100. See Fig. 4-4 ②.
2. Adjust RG,BG so that the levels are suitable to each local area.

(c) High-Light Adjustment

1. Set SCT to 55 FL (20". 21"), 65 FL(14") in the Factory Service Mode with using CA100. See Fig. 4-4 ①.

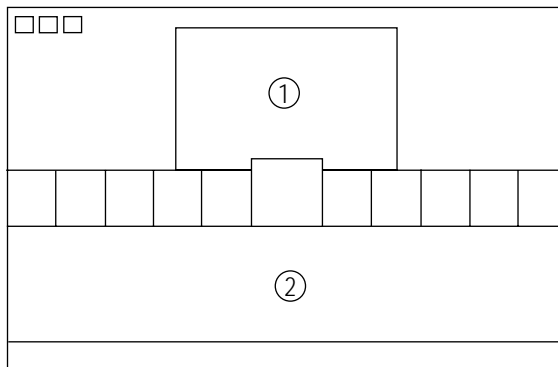

Fig. 4-4

4-3-8 Center Convergence Adjustment

1. Warm up the receiver for at least 20 minutes.
2. Adjust the two tabs of the 4 pole magnets to change the angle between them. Superimpose the red and blue vertical lines in the center area of the screen.
3. Adjust the Brightness and Contrast controls for a well defined picture.
4. Adjust the two-tab pairs of the 4 pole magnets, and change the angle between them. Superimpose the red and the blue vertical lines in the center area of the screen.
5. Turn the both tabs at the same time, keeping the angle constant, and superimpose the red and blue horizontal line in the center of the screen.
6. Adjust the two-tab pairs of the 6-pole magnets to superimpose the red and blue line onto the green. (Changing the angle affects the vertical lines, and rotating both magnets affects the horizontal lines.)
7. Repeat adjustments 2~6, if necessary.
8. Since the 4-pole magnets and 6-pole magnets interact, the dot movement is complex (Fig. 4-5).



Fig. 4-5 Center Convergence Adjustment

4-3-9 RF AGC Adjustment

Set the AGC data to 23 (Factory Mode).

4-3-10 Sub-Color Adjustment

Set $\frac{PSR}{NSR}$ data to $\frac{2}{5}$ (Factory Mode).

4-3-11 Geometry Adjustment

SC → VS → VSL → HS

1. Input a lion head pattern (in the PAL channel).
2. Set the SC (S-Correction) as follows : 9 (21"), 9 (20"), 0 (14") and VA 40 so that the lion head circle becomes oval.
3. Adjust with VSL (Vertical-Slope) so that the bottom margin of the picture is 4.

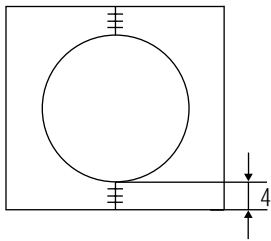

Fig. 4-7

4. Adjust with VS (Vertical shift) so that the top margin of the picture is 4.

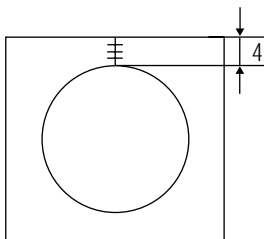

Fig. 4-8

5. Adjust with HS (Horizontal Shift) so that the lion-head pattern and CRT centers are aligned.

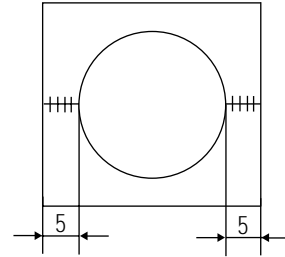

Fig. 4-9

6. Adjust HS (using the width coil) so that the left and right margins of the picture are 5.